



**APPLICANT:** Vinings Jubilee Partners, LTD

**PETITION No.:** V-34

**PHONE:** 770-438-8080

**DATE OF HEARING:** 05-09-2018

**REPRESENTATIVE:** J. Kevin Moore

**PRESENT ZONING:** NRC, NS

**PHONE:** 770-429-1499

**LAND LOT(S):** 908, 909, 952, 953

**TITLEHOLDER:** Vinings Jubilee Partners, LTD

**DISTRICT:** 17

**PROPERTY LOCATION:** On the south and west side of Paces Ferry Road, east of CSX railline, bisected by New Paces Ferry Road, (4300 Paces Ferry Road, 2850 Paces Ferry Road, 2950 New Paces Ferry Road).

**SIZE OF TRACT:** 9.71 acres

**COMMISSION DISTRICT:** 2

**TYPE OF VARIANCE:** 1) Waive the minimum sign setback requirement of 62 feet from the center of an arterial road right-of-way; 2) waive the minimum sign setback requirement of 42 feet from the center of any other road right-of-way; 3) waive the requirement that all ground-based monument-style signage must be located a minimum of one (1) foot from the existing public right-of-way; and 4) waive the requirement for ground based monument style signage to allow the signs depicted in the attached renderings.

**OPPOSITION:** No. OPPOSED **PETITION No.**        **SPOKESMAN**       

**BOARD OF APPEALS DECISION**

**APPROVED**        **MOTION BY**       

**REJECTED**        **SECONDED**       

**HELD**        **CARRIED**       

**STIPULATIONS:**       

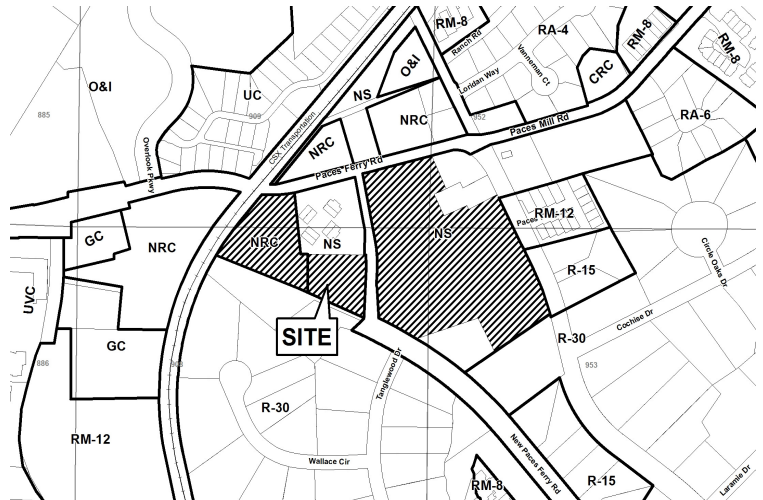

**APPLICANT:** Vinings Jubilee Partners,  
LTD

---

**PETITION No.:** V-34

---

\*\*\*\*\*

**COMMENTS**

**TRAFFIC:** Recommend monument signs be placed off the right-of-way and installed where it will not impede the line of sight for the driveways or roadways.

**DEVELOPMENT & INSPECTIONS:** No comments.

**SITE PLAN REVIEW:** No comments.

**STORMWATER MANAGEMENT:** No comments.

**HISTORIC PRESERVATION:** No comments.

**DESIGN GUIDELINES:** No comments.

**CEMETERY PRESERVATION:** There is no significant impact on the cemetery site listed in the Cobb County Cemetery Preservation Commission's Inventory Listing which is located in this, or adjacent lot.

**WATER:** Signs may not be placed within County water easements or over County water facilities

**SEWER:** Signs may not be placed within County water easements or over County water facilities

**APPLICANT:** Vinings Jubilee Partners,  
LTD

---

**PETITION No.:** V-34

---

\*\*\*\*\*

**FIRE DEPARTMENT:** No comments.

# V-34 2018-GIS

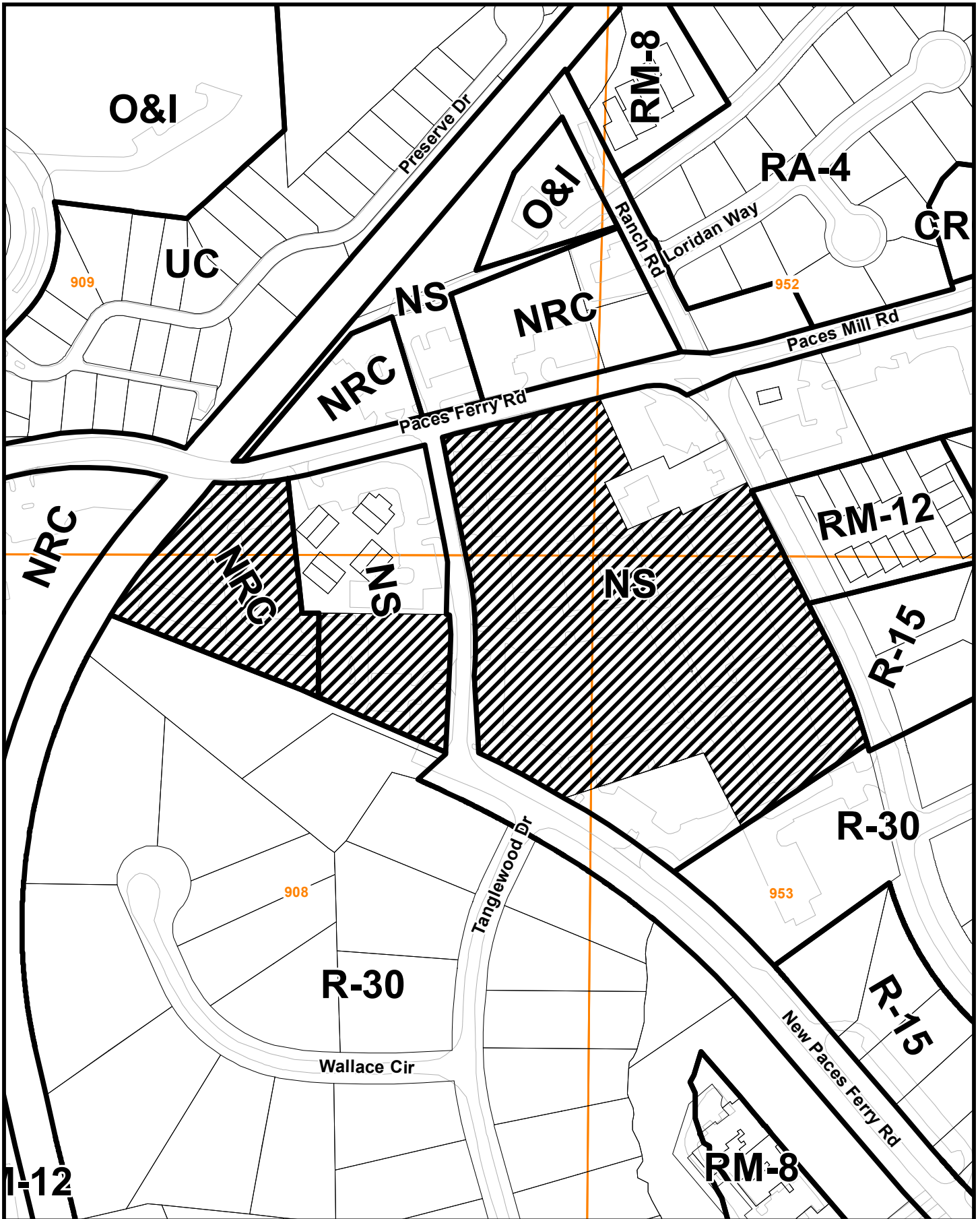

This map is provided for display and planning purposes only. It is not meant to be a legal description.

0 100 200  
Feet

Land Lot  
City Boundary

RECEIVED  
MAR - 8 2018

# Application for Variance Cobb County

COBB CO. COMM. DEV. AGENCY  
ZONING DIVISION

(type or print clearly)

Application No. V- 34 (2018)  
Hearing Date: 05/09/2018

Vinings Jubilee Partners, Ltd.,  
Applicant a Georgia limited partnership Phone # (770) 438-8080 E-mail spetters@pacesholdings.com  
Moore Ingram Johnson & Steele, LLP Emerson Overlook, Suite 100, 326 Roswell Street  
J. Kevin Moore Address Marietta, GA 30060  
(representative's name, printed) (street, city, state and zip code)

BY: [Signature] Phone # (770) 429-1499 E-mail jkm@mijs.com  
(representative's signature) Georgia Bar No. 519728

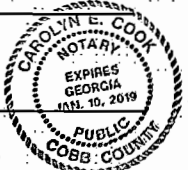

Signed, sealed and delivered in presence of:  
Carolyn E. Cook  
Notary Public

My commission expires: January 10, 2019

Vinings Jubilee Partners, Ltd.,  
Titleholder a Georgia limited partnership Phone # (770) 438-8080 E-mail spetters@pacesholdings.com  
Suite 363, 4300 Paces Ferry Road  
Signature See Attached Exhibit "A" Address: Atlanta, GA 30339  
(attach additional signatures, if needed) (street, city, state and zip code)

Signed, sealed and delivered in presence of:

My commission expires: \_\_\_\_\_

Notary Public

Present Zoning of Property NS, NRC  
Southernly and westerly sides of Paces Ferry Road; easterly and westerly sides of New Paces Ferry Road;  
Location Easterly of W. & A. Railroad (4300 Paces Ferry Road; 2850 Paces Ferry Road; 2950 New Paces Ferry Road)  
(street address, if applicable; nearest intersection, etc.)

Land Lot(s) 908, 909, 952, 953 District 17th Size of Tract 7.161 +/- (Parcel 1) Acre(s)  
9.711 +/- (Overall)

Please select the extraordinary and exceptional condition(s) to the piece of property in question. The condition(s) must be peculiar to the piece of property involved.

Size of Property \_\_\_\_\_ Shape of Property \_\_\_\_\_ Topography of Property \_\_\_\_\_ Other X

Does the property or this request need a second electrical meter? YES \_\_\_\_\_ NO X

The Cobb County Zoning Ordinance Section 134-94 states that the Cobb County Board of Zoning Appeals must determine that applying the terms of the Zoning Ordinance without the variance would create an unnecessary hardship. Please state what hardship would be created by following the normal terms of the ordinance:  
See Exhibit "B" attached hereto and incorporated herein by reference.

List type of variance requested: (1) Waiver of the minimum yard requirement of sixty-two (62) feet from the center of an arterial road right-of-way (See Sec. 134-313(i)(1)); (2) Waiver of the minimum yard requirement of forty-two (42) feet from the center of any other road right-of-way (See Sec. 134-313(i)(1)); and (3) Waiver of the requirement that all ground-based monument-style signage must be located a minimum of one (1) foot from the existing public right-of-way (See Sec. 134-313(i)(2)).

**RECEIVED**  
 MAR - 8 2018  
 COBB CO. COMM. DEVELOPMENT  
 ZONING DIVISION

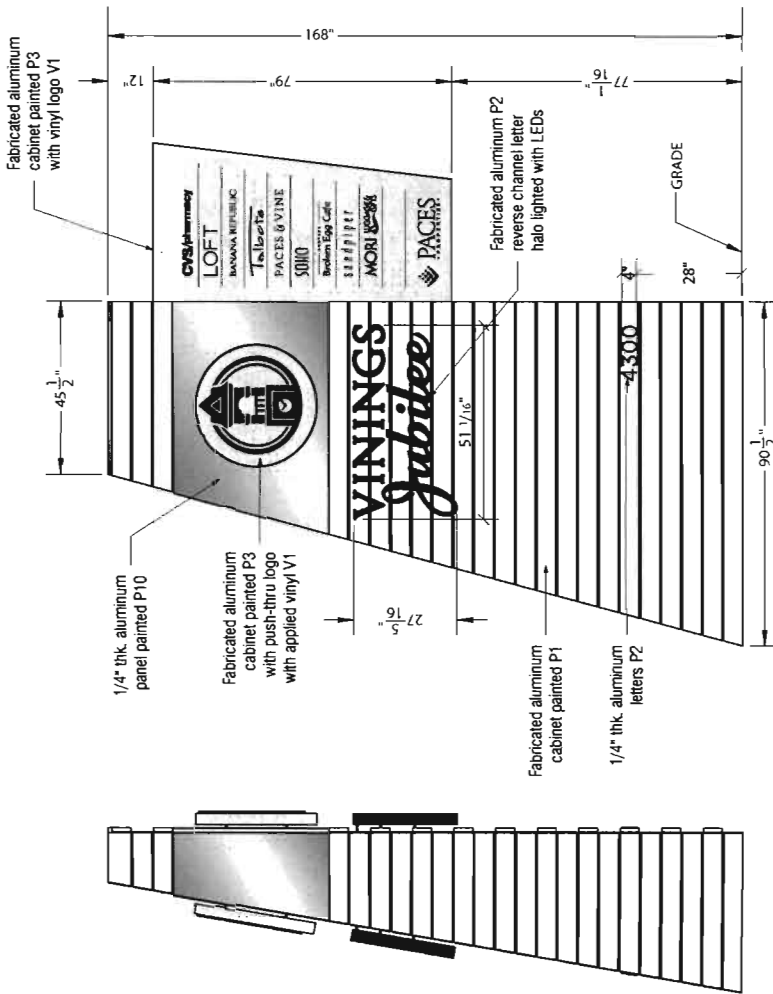
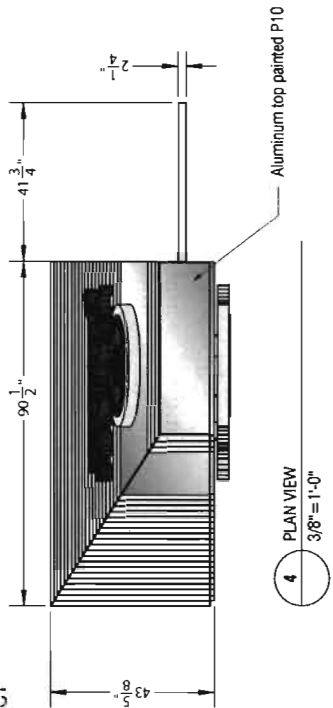
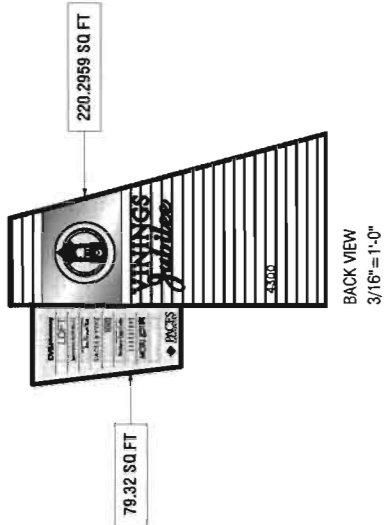

5405 Buford Hwy, Ste. 270  
 Norcross, GA 30071  
 678.580.3281

These drawings were produced by IMG for the sole purpose of conveying our intended manufacturing process. They are not to be used for any other purpose. The design and construction of the sign are the property of IMG. Permission to copy, reproduce, or otherwise use these drawings without the written consent of IMG is prohibited.



VININGS JU  
 V-34  
 (2018)  
 Exhibit

SOFT: 3  
 SR: D  
 PM: JA  
 SCALE: NOTED  
 DATE: 07/20/17  
 DSR: GT  
 SUBMITTED:  
 REVISED:

RELEASED:  
 UPDATED:  
 RELEASE:

SIGN TYPE: A  
 PRIMARY ID MONUMENT

FILE LOCATION:  
 \\NAS-550001\Projects\2018\Signs\Submittals\2018\_Vinings\_Jubilee\_6\_Arch\Sign ID Monument

EXHIBIT "1"

**RECEIVED**  
 MAR - 8 2018

COBB CO. COMM. DEV. AGENCY  
 ZONING DIVISION

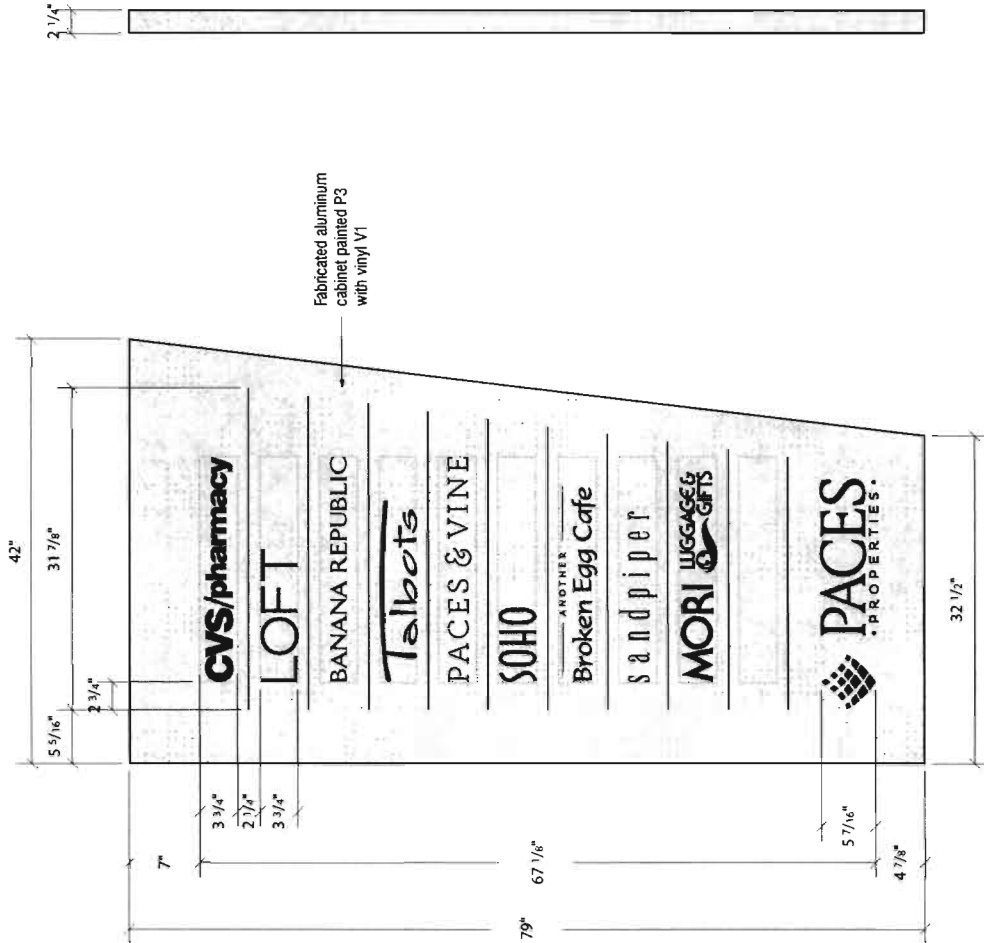

1 FRONT VIEW  
 1" = 1'-0"

2 SIDE VIEW  
 1" = 1'-0"

3 BACK VIEW  
 1" = 1'-0"



5405 Buford Hwy, Ste. 270  
 Norcross, GA 30071  
 678.580.3281

These drawings were produced by IMG for the sole purpose of conveying our intended manufacturing process to the fabricator. They are not to be used for any other purpose. All trademarks and service marks are the property of their respective owners. No liability is assumed by IMG for any errors or omissions. All dimensions are in inches unless otherwise noted. Any fabrication changes must be written consent with IMG.



VININGS JU  
 V-34  
 (2018)  
 Exhibit

SO#: 3  
 SR: D  
 PM: JA  
 SCALE: NOTED  
 DATE: 07/21/17  
 DSR: GT  
 SUBMITTED: 07/21/17  
 REVISED:

RELEASED:  
 UPDATED  
 RELEASE:

SIGN TYPE: A  
 PRIMARY ID MONUMENT

FILE LOCATION  
 VMS-SERIES: Signage & Monuments  
 2018\_Vinings\_Jubilee\_V-D\_Primary ID Monument



**RECEIVED**  
MAR - 8 2018  
COBB CO. COMM. DEV. AGENCY  
ZONING DIVISION

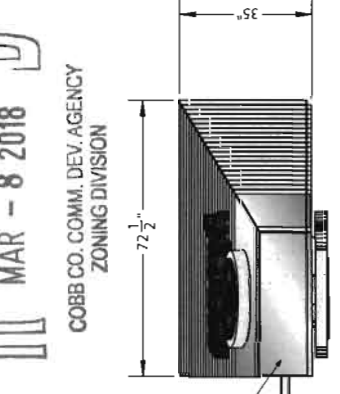
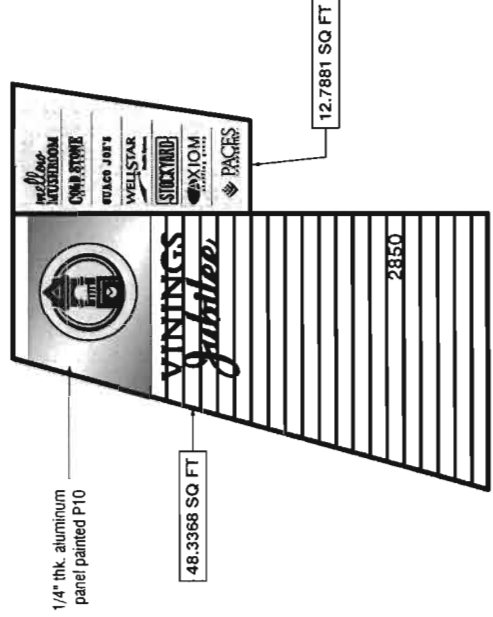

4 PLAN VIEW  
3/8" = 1'-0"

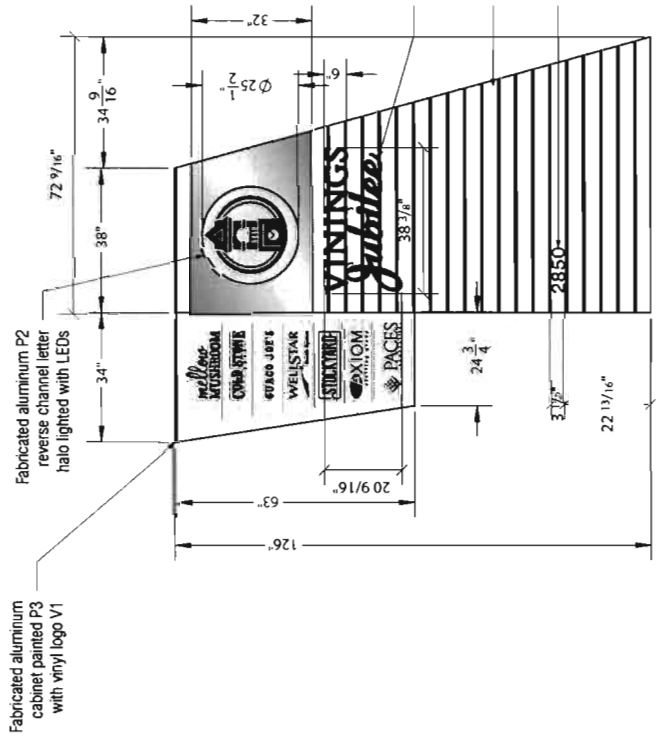

1 FRONT VIEW - FRONT  
3/8" = 1'-0"

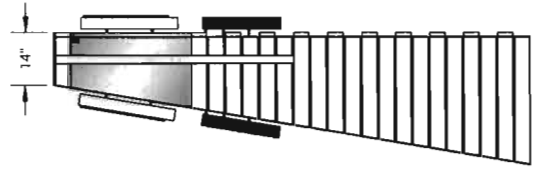

2 FRONT VIEW - LEFT  
3/8" = 1'-0"

5 BACK VIEW  
3/8" = 1'-0"



3 FRONT VIEW - RIGHT  
3/8" = 1'-0"



5405 Buford Hwy, Ste. 270  
Norcross, GA 30071  
678.580.3281

These drawings were produced by IMG for the sole purpose of conveying information and are not to be used for any other purpose without the express written consent of IMG. These manufacturing techniques are the property of IMG and shall remain confidential. No part of these drawings shall be reproduced or transmitted in any form or by any means without the express written consent of IMG.



VININGS JUBILEE  
V-34  
(2018)  
Exhibit

SO: J  
SR: D  
PM: JA  
SCALE: NOTED  
DATE: 07/23/17  
SUBMITTED: GT  
REVIS: GT

RELEASED:  
UPDATED:  
RELEASE:

SIGN TYPE: B.1  
SECONDARY ID MONUMENT

RULE LOCATION  
VININGS Jubilee (2018) Exhibit  
2000\_Vinings\_Jubilee\_2018\_03-Secondary ID Monument

**RECEIVED**  
MAR - 8 2018

COBB CO. COMM. DEV. AGENCY  
2 1/4" ZONING DIVISION

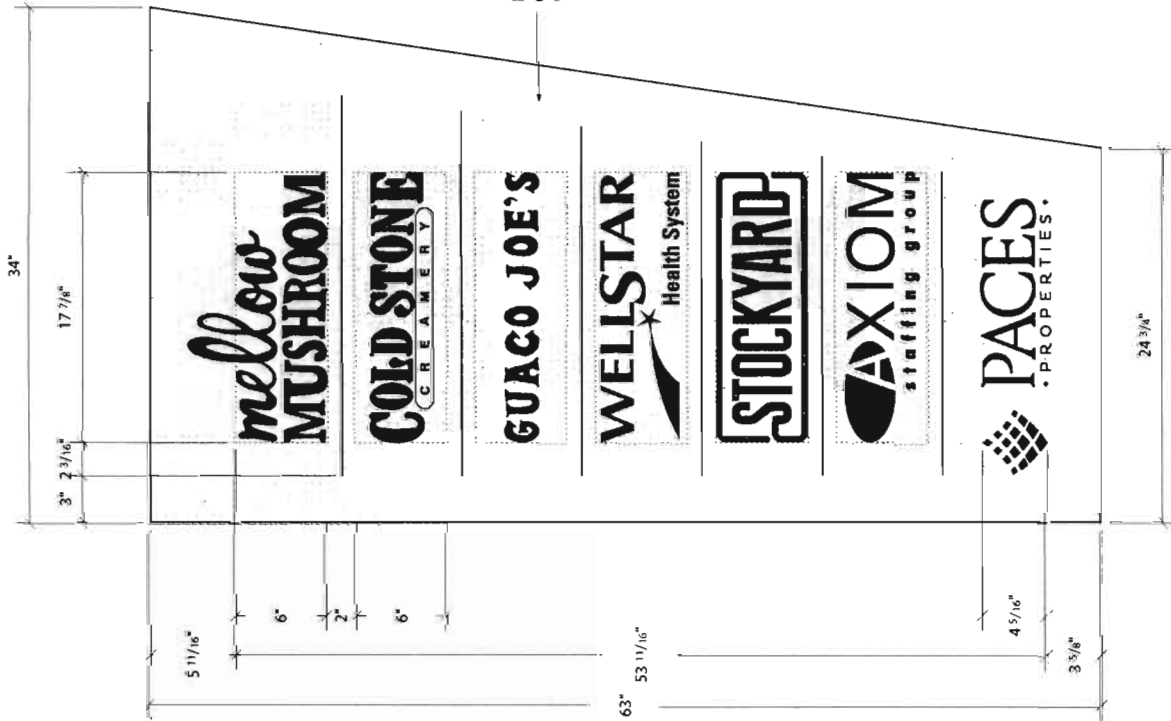

1 FRONT VIEW  
1-1/2"=1'-0"

2 SIDE VIEW  
1-1/2"=1'-0"

3 BACK VIEW  
1-1/2"=1'-0"



5405 Buford Hwy., Ste. 270  
Norcross, GA 30071  
678.580.3281

These drawings were produced by IMG for the sole purpose of conveying our intended manufacturing process to the contractor. They are not to be used for any other purpose without the express written consent of IMG. Permission to copy, distribute to others or otherwise use these drawings in any form without the written consent of IMG.



VININGS JU  
V-34  
(2018)  
Exhibit

SO: 3  
SR: D  
PK: JA  
SCALE: NOTED  
DATE: 07/21/17  
SUBMITTED: 07/21/17  
REVIS: GT  
DSR: GT

RELEASED:  
UPDATED:  
RELEASE:

SIGN TYPE: B.1  
SECONDARY ID MONUMENT

FILE LOCATION:  
\\img-servers\img\Projects\2018\_Vinings\_Jubilee\2\_Banner\2\_Banner\2\_Banner.dwg

RECEIVED  
MAR - 8 2018

COBIB CO. COMM. DEV. AGENCY  
ZONING DIVISION

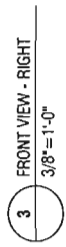
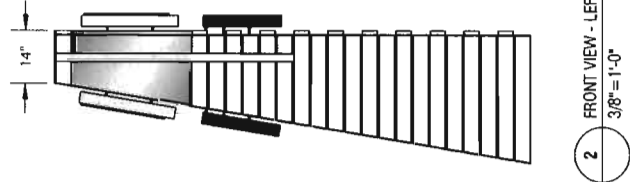
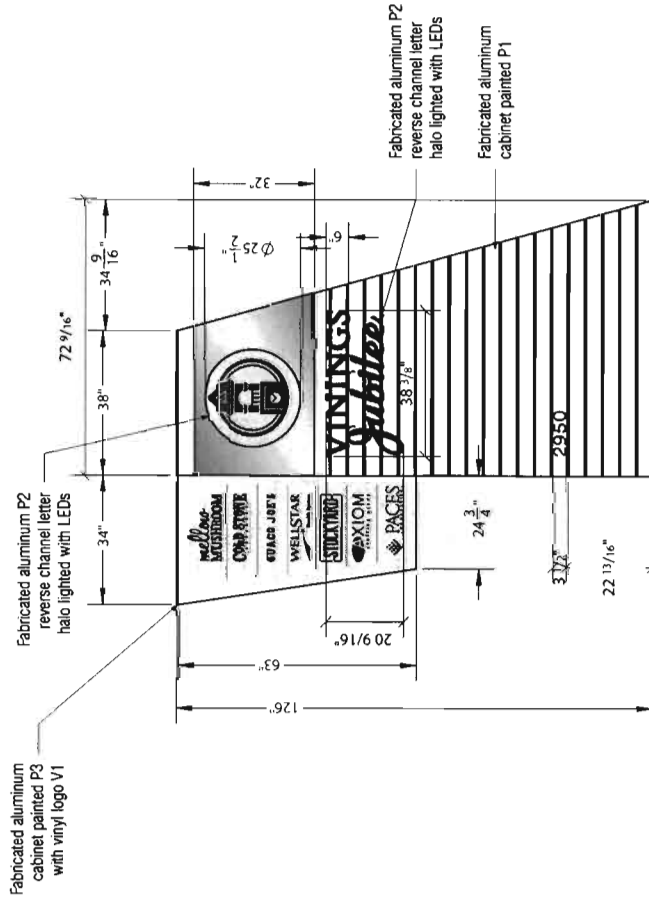
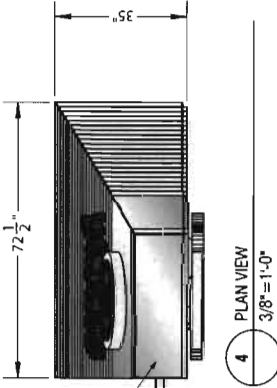
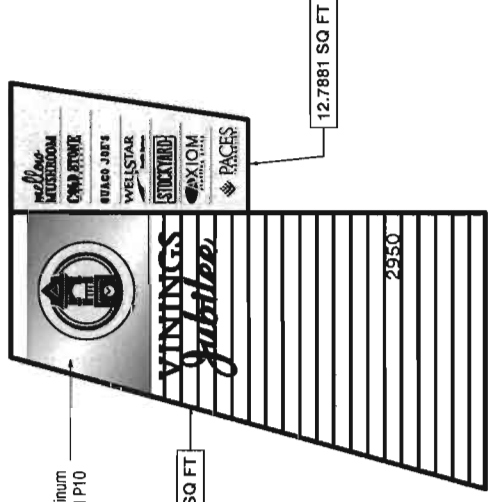

5405 Buford Hwy., Ste. 270  
Norcross, GA 30071  
678.580.3281

These drawings were produced by IMG for the sole purpose of conveying our standard manufacturing process to the fabricator. They are not to be used for any other purpose without the express written consent of IMG. Permission to copy, distribute to others, or modify these drawings without their consent through a written contract with IMG.



VININGS JU  
V-34  
(2018)  
Exhibit

SO#: 36 DE  
SR: JA  
PM: JA  
SCALE: NOTED  
DATE: 07/21/17  
SUBMITTED: DSR: GT  
REVISED: GT

RELEASED:  
UPDATED:  
RELEASE:

SIGN TYPE: B.2  
SECONDARY ID MONUMENT

FILE LOCATION  
\\img-scr\img\signs\2018\2018\_Vinings\_Jubilee\_P2\_Secundary ID Monument

**RECEIVED**  
MAR - 8 2018

COBB CO. COMM. DEV. AGENCY  
ZONING DIVISION

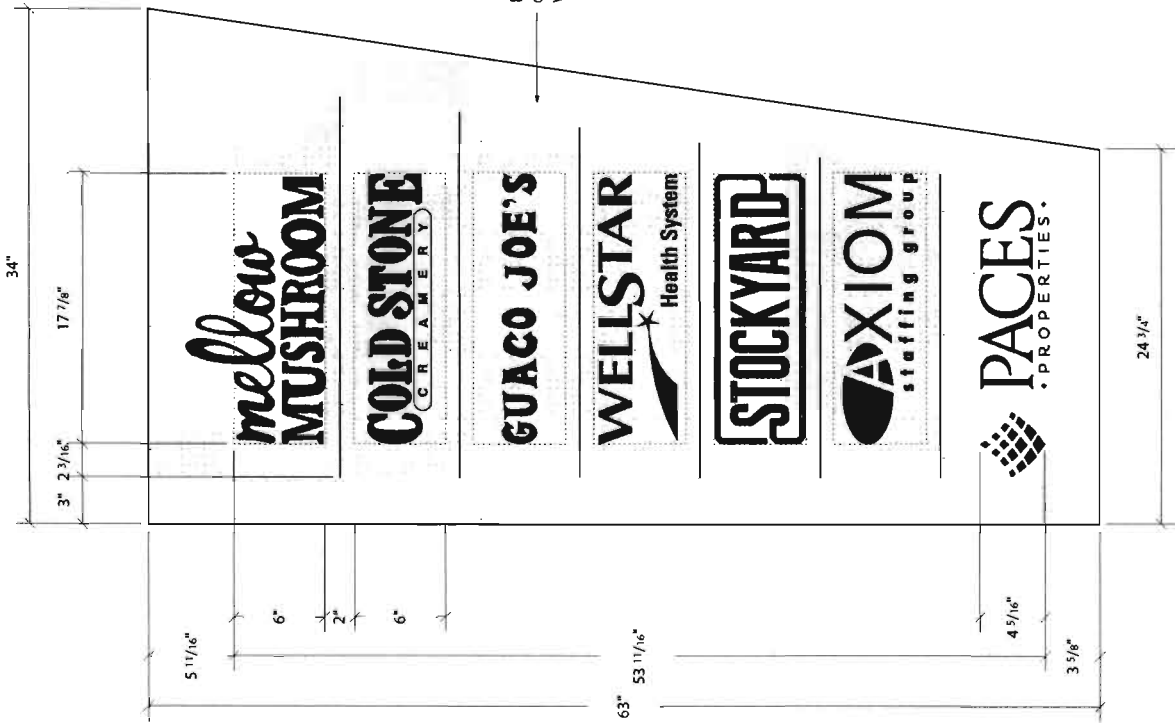

1 FRONT VIEW  
1-1/2" = 1'-0"

2 SIDE VIEW  
1-1/2" = 1'-0"

3 BACK VIEW  
1-1/2" = 1'-0"

**img**  
Image  
Manufacturing  
Group

5405 Buford Hwy, Ste. 270  
Norcross, GA 30071  
678.580.3281

These drawings were produced by IMG for the sole purpose of conveying our intended manufacturing process. They are not to be used for any other purpose. These manufacturing techniques are the property of IMG. No part of this drawing is to be reproduced, stored in a retrieval system, or transmitted in any form or by any means, electronic, mechanical, photocopying, recording, or by any information storage and retrieval system, without consent from IMG.

**VININGS**  
*Jubilee*

VININGS JU  
V-34  
(2018)  
Exhibit

SO: 3  
SR: D  
PM: JA  
SCALE: NOTED  
DATE: 07/23/17  
SUBMITTED: DSR: GT  
REVISED:

RELEASED:  
UPDATED  
RELEASE:

SIGN TYPE: B.2  
SECONDARY ID MONUMENT

FILE LOCATION:  
\\MS-SRVE1\Engineering\Drawings\Sublet  
2017\_Vinings\_Jubilee\2.0\_B\_Secondary ID Monument

PAGE  
2.3

**RECEIVED**  
MAR - 8 2018

COBB CO. COMM. DEV. AGENCY  
ZONING DIVISION

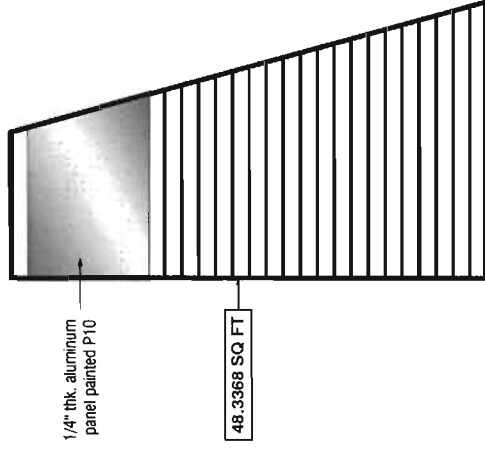

4 BACK VIEW  
3/8" = 1'-0"

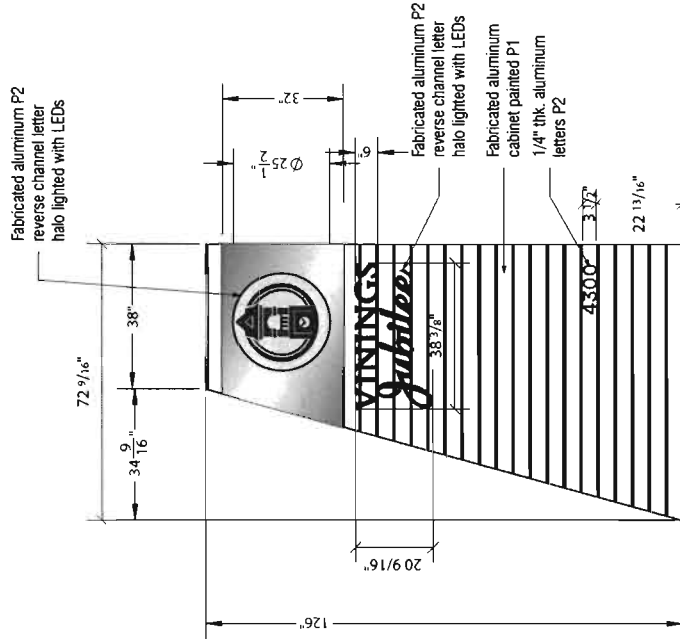

1 FRONT VIEW  
3/8" = 1'-0"



2 FRONT VIEW - LEFT  
3/8" = 1'-0"

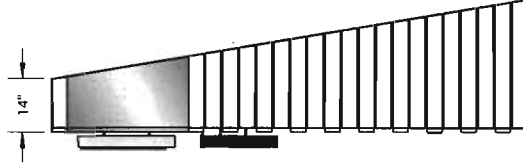

3 FRONT VIEW - RIGHT  
3/8" = 1'-0"



5405 Buford Hwy., Ste. 270  
Norcross, GA 30071  
678.580.3281

These drawings were produced by IMG for the sole purpose of conveying our intended manufacturing intent. They are not to be used for any other purpose. These manufacturing techniques are the property of IMG. Permission to copy, reproduce or otherwise use these drawings without the written consent of IMG.



**VININGS**  
*Jubilee*

VININGS JU  
V-34  
(2018)  
Exhibit

SO: 3  
DR: D  
PK: JA  
SCALE: NOTED  
DATE: 07/21/17  
DSR: GT  
SUBMITTED: 07/21/17  
REVISED:

RELEASED:  
UPDATED  
RELEASE:

SIGN TYPE: B.3  
SECONDARY ID MONUMENT

FILE LOCATION  
\\NAS-SERVER\Engineering\2018\New\Jubilee  
2018\_Vinings\_Jubilee\2.0\_B-Secondary ID Monument

V-34  
(2018)  
Exhibit

**EXHIBIT "A" - ATTACHMENT TO APPLICATION FOR VARIANCE**

RECEIVED  
MAR - 8 2018

COBB CO. COMM. DEV. AGENCY  
ZONING DIVISION

Application No.: V- 34 (2018)  
Hearing Date: May 9, 2018

Applicant/Titleholder: **Vinings Jubilee Partners, Ltd.,  
a Georgia limited partnership**

VININGS JUBILEE PARTNERS, LTD.,  
a Georgia limited partnership

BY: DFP, INC., a Georgia corporation  
its General Partner

BY: George A. Pettus  
TITLE: President

[Corporate Seal]

Printed Name: George A. Pettus

Date Executed: MAR 7 '18

Address: Suite 363, 4300 Paces Ferry Road  
Atlanta, Georgia 30339

Telephone No.: (770) 438-8080

Signed, sealed, and delivered  
in the presence of:

Karen Adele Harvill  
Notary Public  
Commission Expires \_\_\_\_\_

(Notary Seal)

KAREN ADELE HARVILL  
MY COMMISSION EXPIRES  
JUNE 13 2018  
COBB COUNTY, GA.  
NOTARY PUBLIC

V-34  
(2018)  
Exhibit

**EXHIBIT "B" - ATTACHMENT TO APPLICATION FOR VARIANCE**

**RECEIVED**  
MAR - 8 2018

Application No.: V- 34 (2018)  
Hearing Date: May 9, 2018

COBB CO. COMM. DEV. AGENCY  
ZONING DIVISION

**BEFORE THE COBB COUNTY BOARD OF ZONING APPEALS**

**Applicant/Titleholder: Vinings Jubilee Partners, Ltd.,  
a Georgia limited partnership**

Please state what hardship would be created by following the normal terms of the ordinance:

Vinings Jubilee Partners, Ltd., as Applicant and Titleholder (hereinafter collectively "Applicant"), is the owner of improved real property totaling 9.711 acres, more or less, located on the southerly and westerly sides of Paces Ferry Road; the easterly and westerly sides of New Paces Ferry Road; easterly of the W. & A. Railroad, being more particularly known as 4300 Paces Ferry Road, 2850 Paces Ferry Road, and 2950 New Paces Ferry Road, Land Lots 908, 909, 952, and 953, 17<sup>th</sup> District, 2<sup>nd</sup> Section, Cobb County, Georgia (hereinafter the "Property" or "Subject Property"). The Property was developed many years ago for the retail center known as "Vinings Jubilee," which is still operational and a key component to the Vinings restaurant and retail area along Paces Ferry Road.

Applicant is proposing to upgrade and completely replace the existing signage for the Vinings Jubilee retail center. Copies of the proposed replacement signage plans are attached collectively as Exhibit "1" to this narrative. Applicant seeks waivers of certain regulations within the Sign Ordinance, as follows:

- (1) Waiver of the minimum yard requirement of sixty-two (62) feet from the center of an arterial road right-of-way;
- (2) Waiver of the minimum yard requirement of forty-two (42) feet from the center of any other road right-of-way; and
- (3) Waiver of the requirement that all ground-based monument-style signage must be located a minimum of one (1) foot from the existing public right-of-way.

Applicant proposes the installation of the new, replacement signage in the exact location as the existing signage, and the current requirements of the Cobb County Sign Ordinance would not allow replacement of the signs. There are no other reasonable locations for placement of the new and updated signage due to the

existing infrastructure and improvements within the Vinings Jubilee retail center than where they are presently located. Additionally, in the years following construction and occupancy of the retail center, the Vinings area has experienced immense growth which has necessitated improvements along the existing rights-of-way, including condemnations of properties for road widenings, construction of new roadways, entrance realignments, and many other improvements which directly affected the Subject Property. Further, the Cobb County Zoning Ordinance and Development Standards which was in effect at the time of development of the retail center have been revised. The waivers as set forth above, must be approved to allow for installation of the updated, replacement signage. To grant the requested variances would result in no detrimental impact upon the Subject Property or any other adjacent or surrounding properties.